

Article number: 204060M1028A0X  
 Description: E+G levelling foot  
 GN 40-60-M10-28-A0-X  
 Note: X With female thread, External hexagon

## Measures

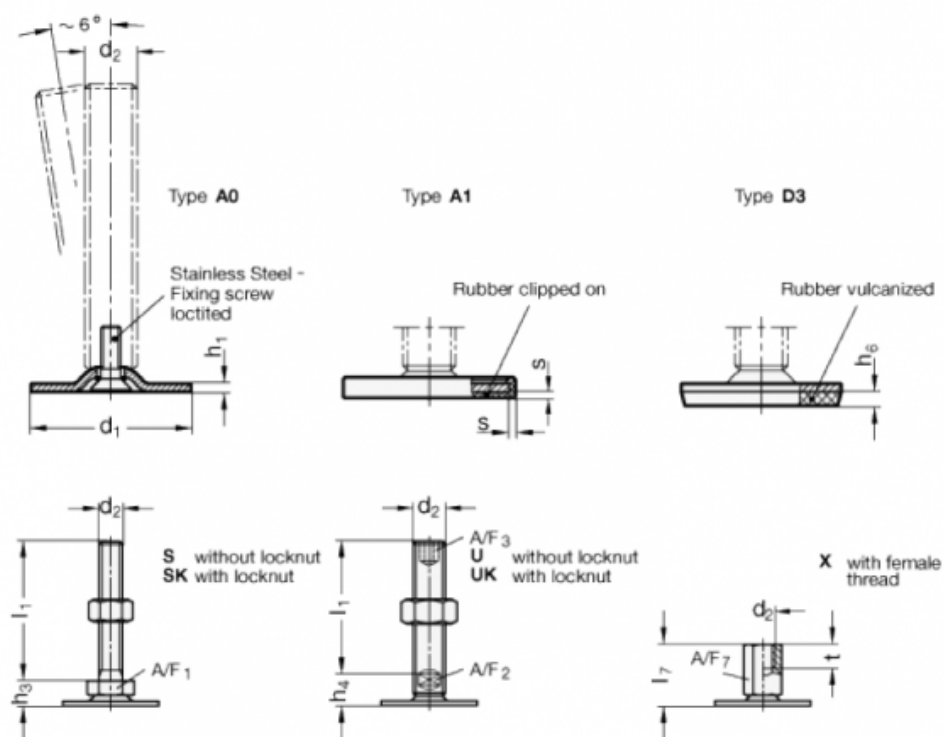

A/F7 = 14  
 d1 = 60  
 d2 = M10  
 h1 = 2.5  
 h6 =  
 l7 = 28  
 s =  
 t = 8